

# $a_1(1260)$ from lattice QCD

Unitarity

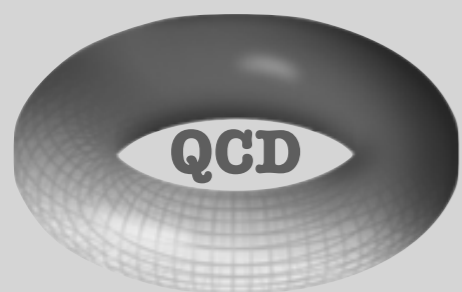

ChPT

**THEORY**

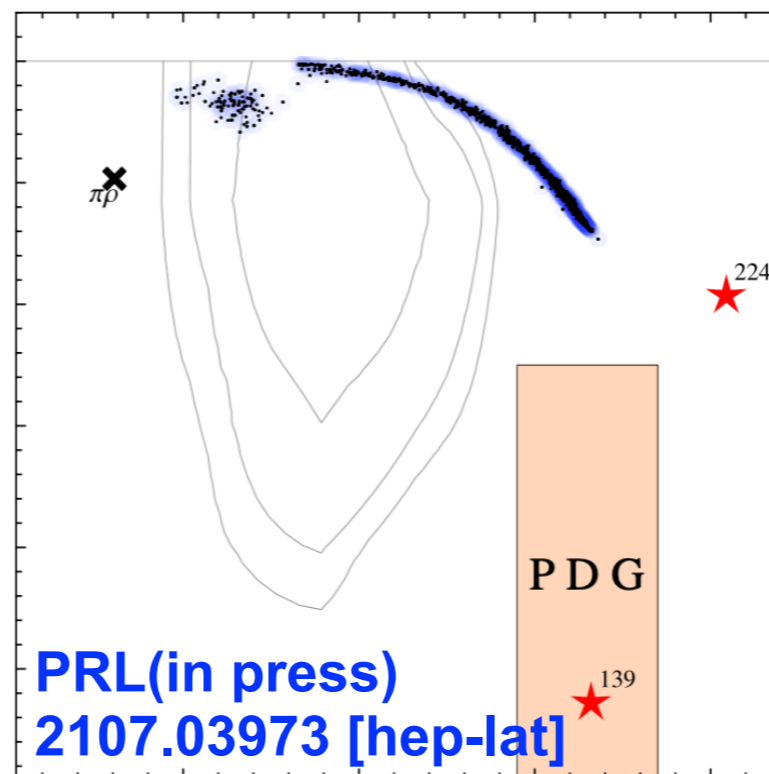

LHC

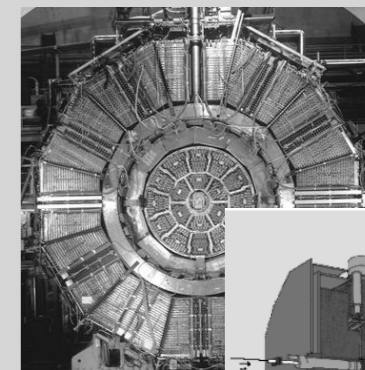

GlueX

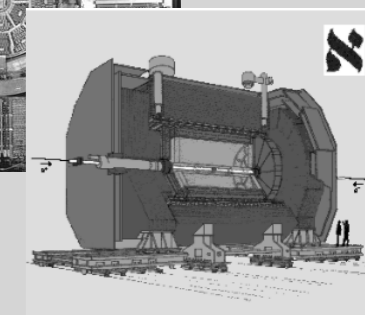

The ALEPH Detector

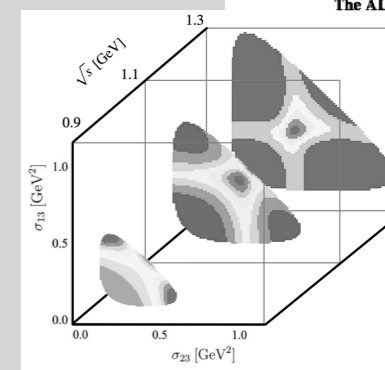

**EXPERIMENT**

*Maxim Mai*

*with A. Alexandru\*, R. Brett\*, C. Culver\*, M. Döring,  
F. Lee\*, D. Sadasivan [\*GWQCD]*



Deutsche  
Forschungsgemeinschaft  
**DFG**

PHY-2012289  
DE-SC0016582 DE-FG02-95ER40907  
MA-7156

# MOTIVATION

**Pattern and production mechanisms** of many excited hadrons are unresolved issues

**Many questions are related to the hadronic 3-body problem**

- $\omega(782)$ ,  $a_1(1260)$ , ...
- Roper resonance  $N^*(1440)$
- exotic mesons:  $\pi_1(1600)$ , ...

(experimental searches @COMPASS, GlueX)

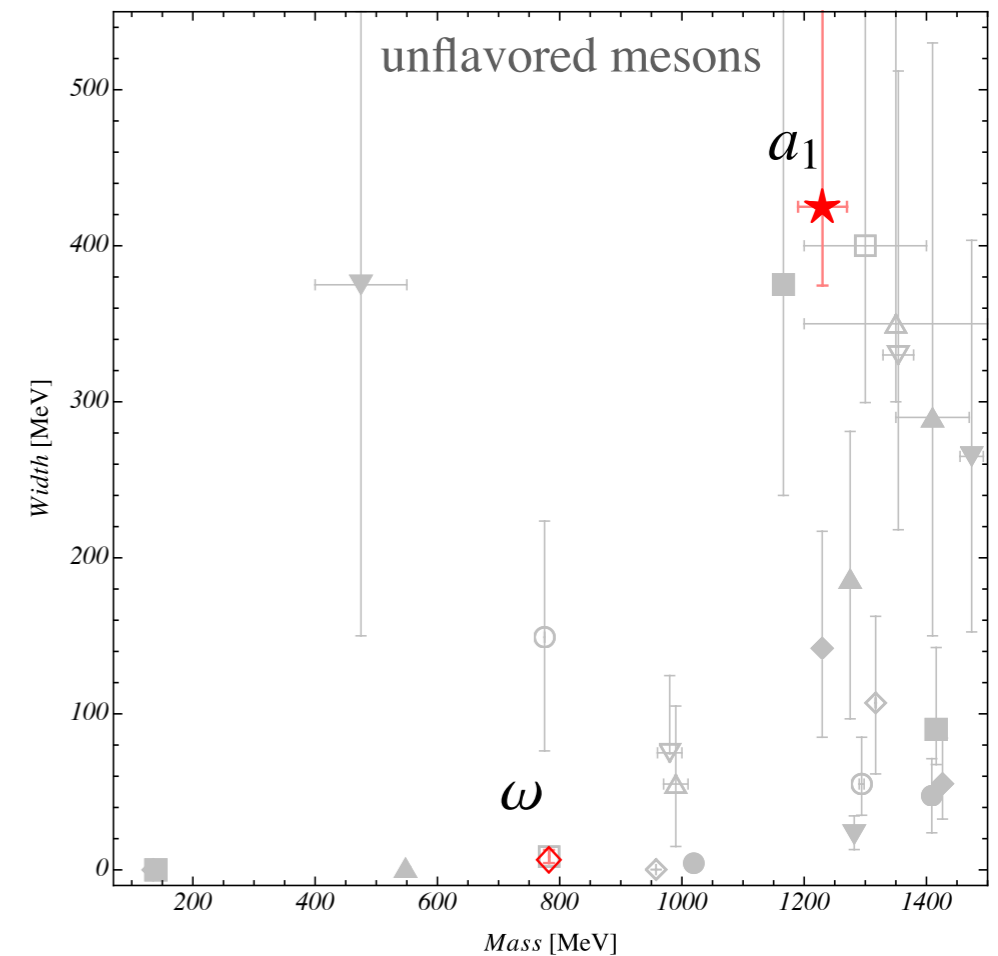

**This work:  $a_1(1260)$  from lattice QCD**

# MOTIVATION

## Universal parameters of resonances from poles on Riemann surface

- 3-step procedure:

# MOTIVATION

## Universal parameters of resonances from poles on Riemann surface

- 3-step procedure:

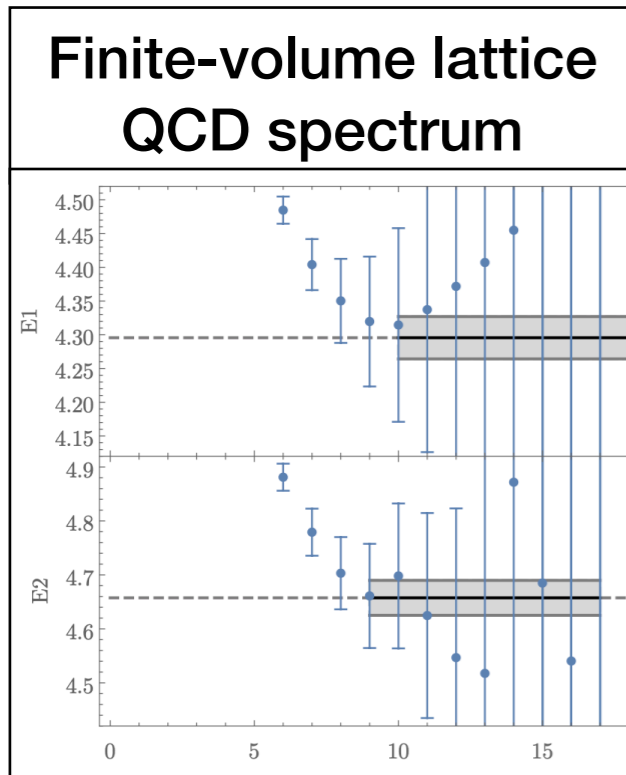

# MOTIVATION

## Universal parameters of resonances from poles on Riemann surface

- 3-step procedure:

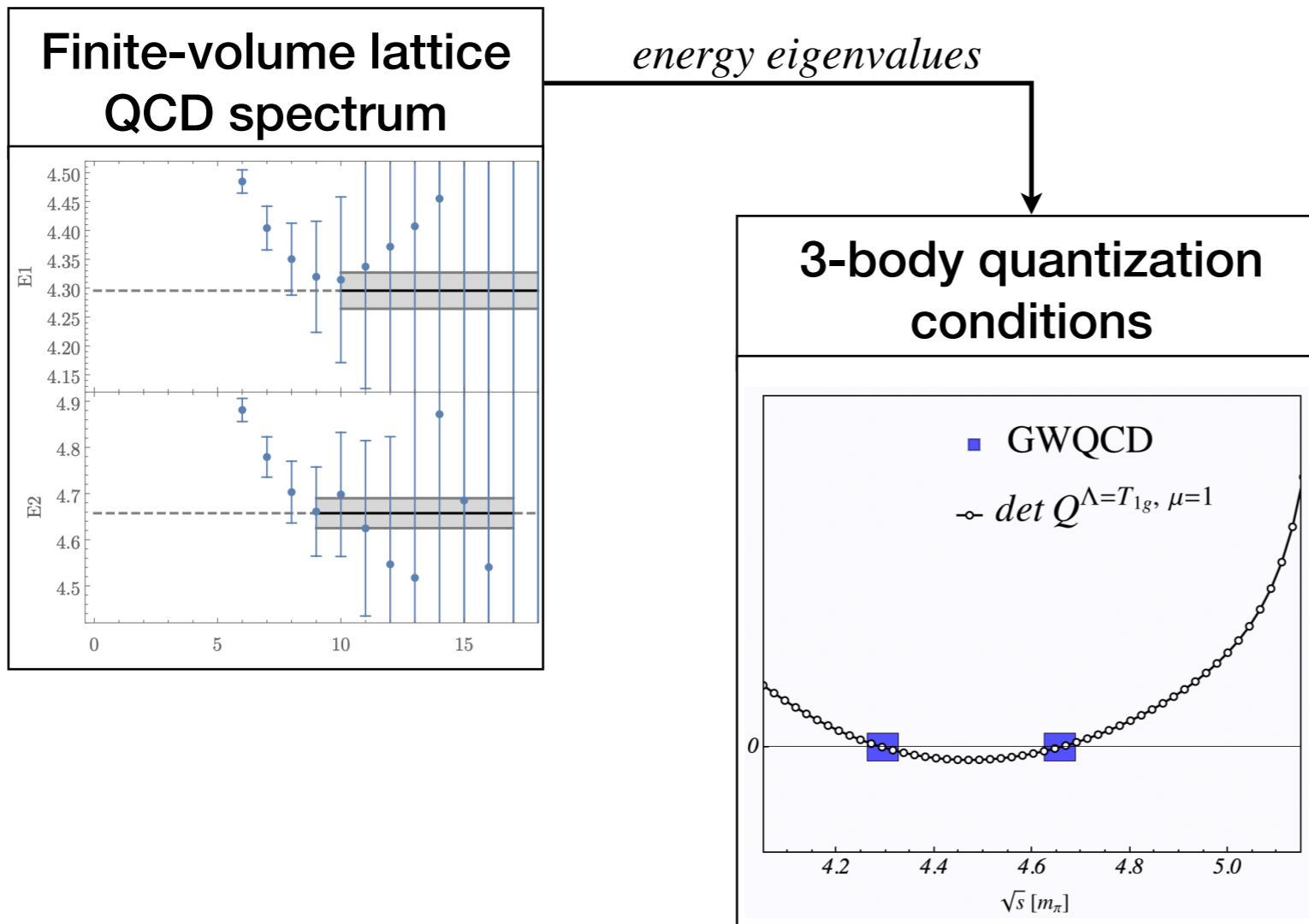

# MOTIVATION

## Universal parameters of resonances from poles on Riemann surface

- 3-step procedure:

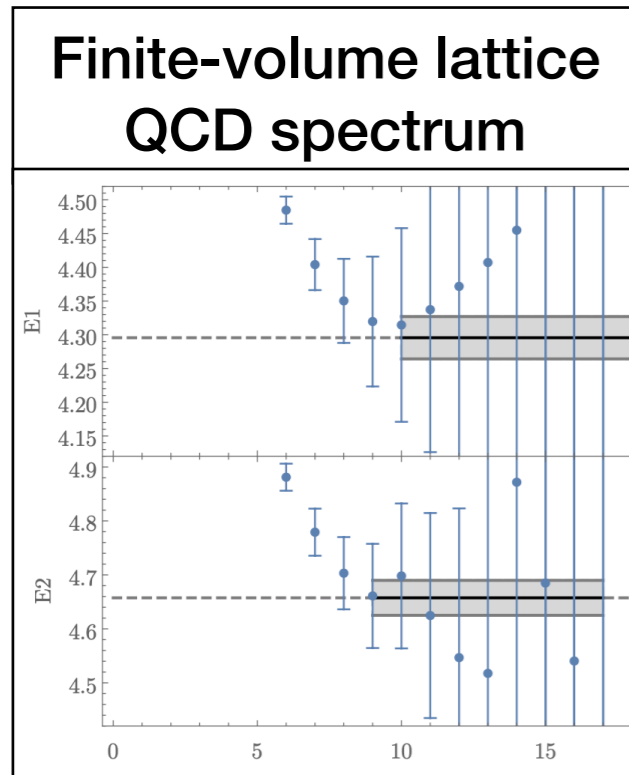

*energy eigenvalues*

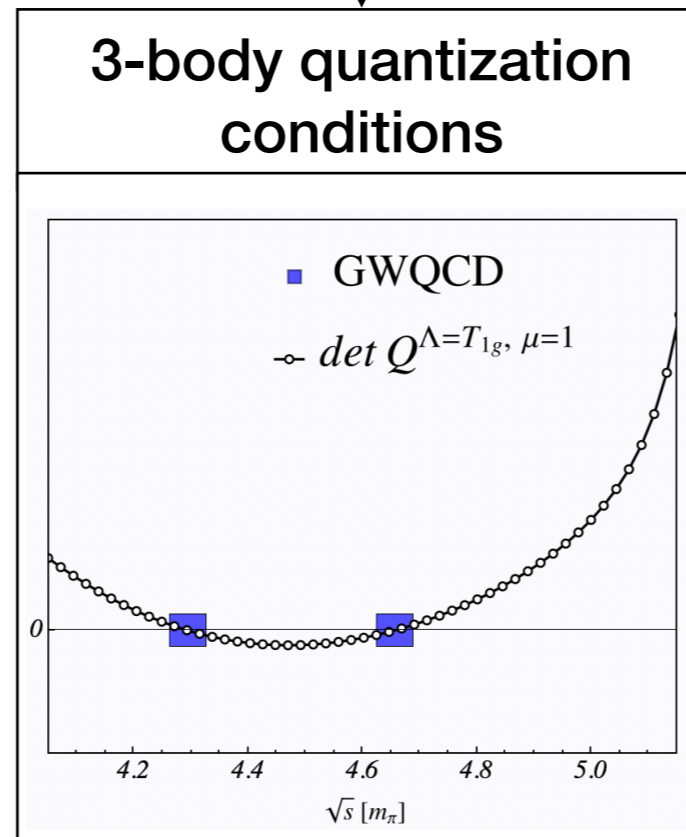

*volume-independent quantities*

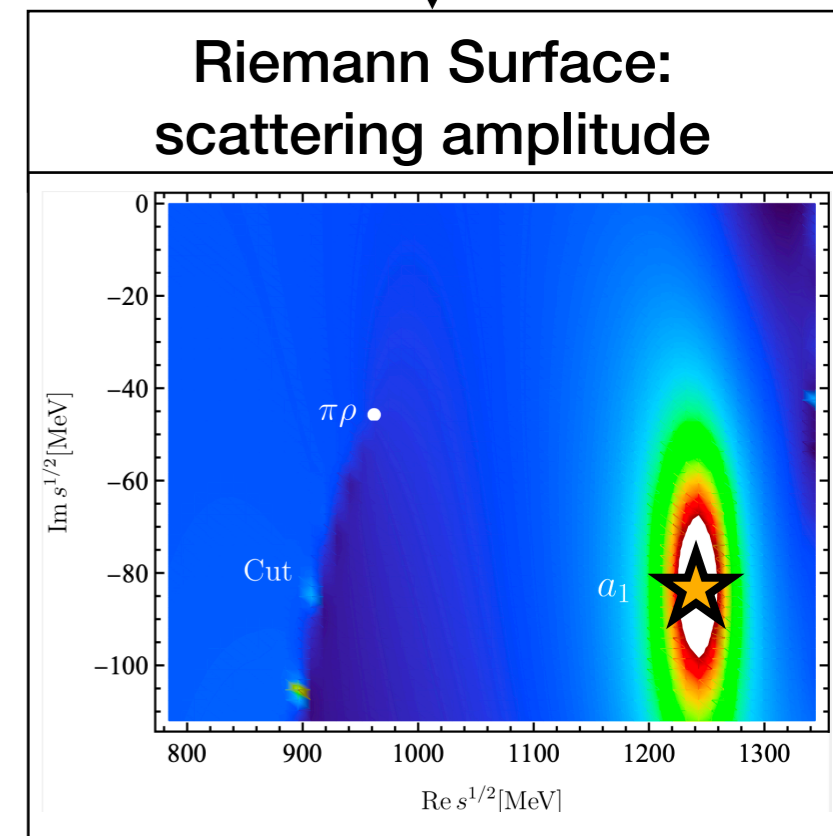

# EXPERIMENT & THEORY

## Phenomenological studies

- A clean way:  $a_1(1260)$  from  $\tau$ -decays (ALEPH@CERN)

Mikhashenko et al. [JPAC] (2018) Sadasivan/MM/Döring(2020)

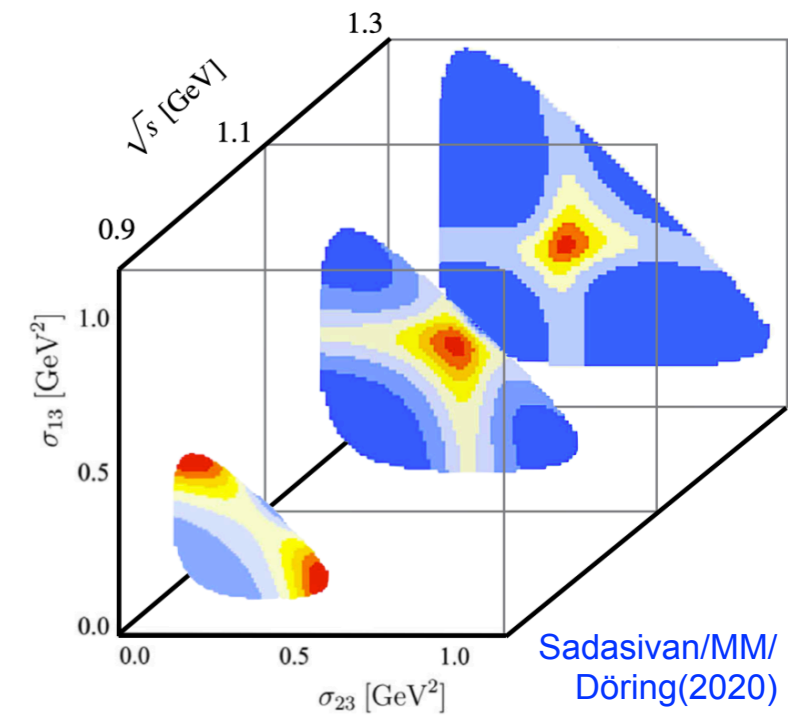

# EXPERIMENT & THEORY

## Phenomenological studies

- A clean way:  $a_1(1260)$  from  $\tau$ -decays (ALEPH@CERN)

Mikhashenko et al. [JPAC] (2018) Sadasivan/MM/Döring(2020)

## Theoretical ab-initio access: lattice QCD

- full quark-gluon dynamics with some technical issues
  1. Discretized Euclidean space-time >> continuum limit
  2. Unphysical pion mass >> chiral extrapolations
  3. Finite Volume >> quantization condition

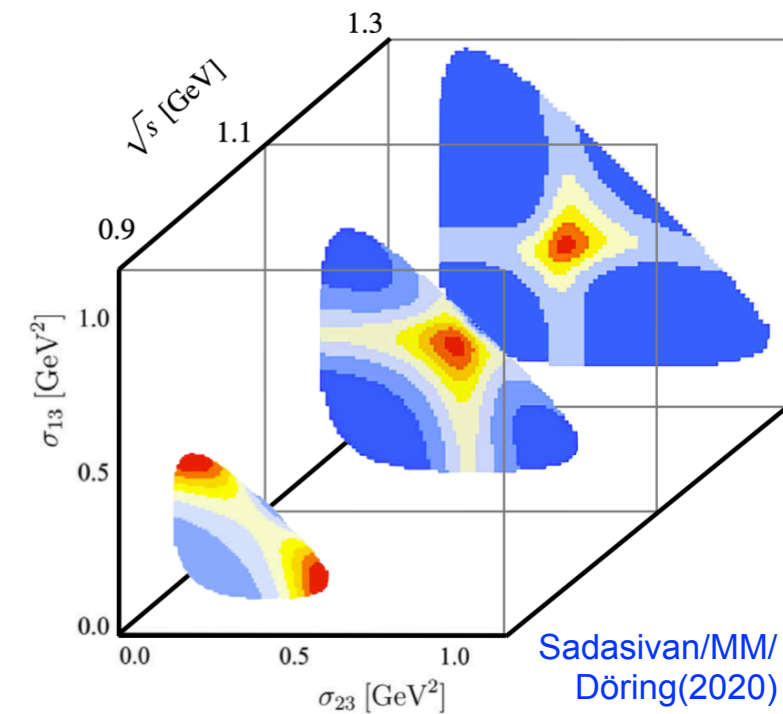



# EXPERIMENT & THEORY

## Phenomenological studies

- A clean way:  $a_1(1260)$  from  $\tau$ -decays (ALEPH@CERN)

Mikhasenko et al. [JPAC] (2018) Sadasivan/MM/Döring(2020)

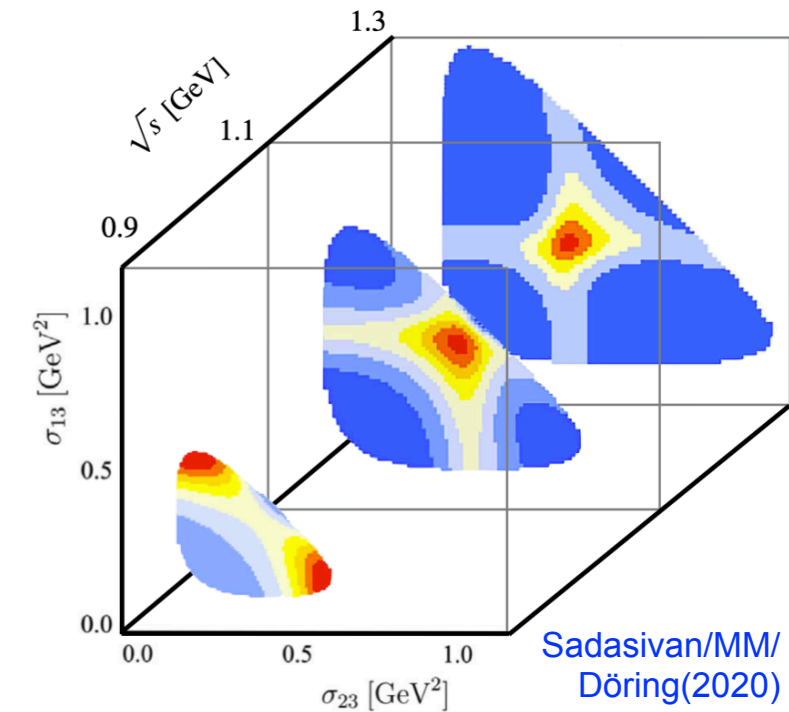

Sadasivan/MM/Döring(2020)

## Theoretical ab-initio access: lattice QCD

- full quark-gluon dynamics with some technical issues

1. Discretized Euclidean space-time >> continuum limit
2. Unphysical pion mass >> chiral extrapolations
3. Finite Volume >> quantization condition

- many studies of 2-body systems

[NPLQCD], [RQCD], [ETMC], [HadSpec], ... **Review: Rev.Mod.Phys. 90 (2018) 2**

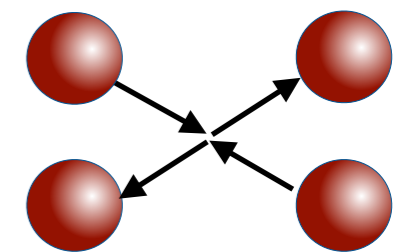
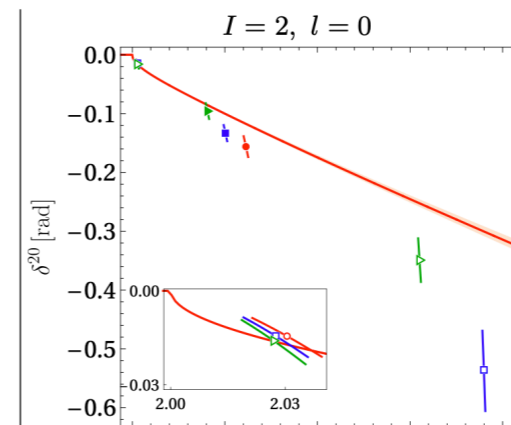
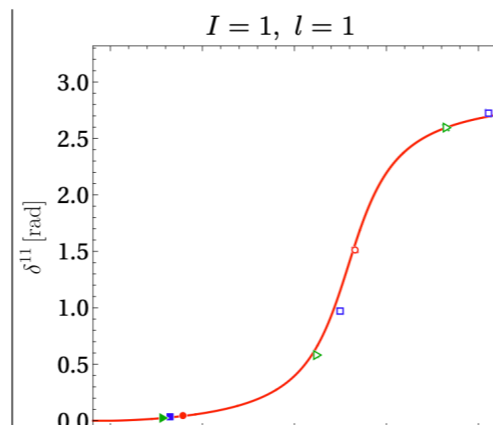
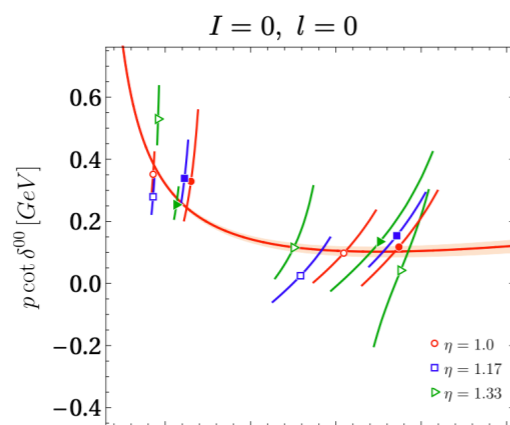

e.g. MM et al. [GWQCD] (2019)

- non-resonant 3-body systems with maximal isospin:  $\pi^+\pi^+\pi^+$ ,  $K^-K^-K^-$ , ...

[NPLQCD]; Hörz/Hanlon; [GWQCD]; [HadSpec]; Blanton et al.

# LATTICE QCD

## Key details of GWQCD lattice QCD calculation

- $N_f = 2$  dynamical fermions, LapH smearing
- $\mathbf{P}=(0,0,0)$ ,  $m_\pi=224$  MeV,  $m_\pi L=3.3$
- *GEVP with one-/two-/three-meson operators*
- *Relevant irrep( $O_h$ ) for  $\mathbf{a}_1(1260)$   $I^G (J^P C) = 1^- (1^{++})$ :*

Alexandru, Brett, Culver, Guo, Lee, Pelissier (2013-2021)  
PRD87,PRD94,PRD98,PRD96,PRL117,PRD100

$\mathbf{P}$	$\Lambda$	$J^P (I^G = 1^-)$
$\mathbf{P} = (0, 0, 0)$	$T_{1g}$	$1^+, 3^+, \dots$
	$A_{1u}$	$0^-, 4^-, \dots$

# LATTICE QCD

## Key details of GWQCD lattice QCD calculation

- $N_f = 2$  dynamical fermions, LapH smearing
- $\mathbf{P}=(0,0,0)$ ,  $m_\pi=224$  MeV,  $m_\pi L=3.3$
- GEVP with one-/two-/three-meson operators
- Relevant irrep( $O_h$ ) for  $a_1(1260)$   $I^G (J^P C) = 1^- (1^{++})$ :

Alexandru, Brett, Culver, Guo, Lee, Pelissier (2013-2021)  
PRD87,PRD94,PRD98,PRD96,PRL117,PRD100

$\mathbf{P}$	$\Lambda$	$J^P (I^G = 1^-)$
$\mathbf{P} = (0, 0, 0)$	$T_{1g}$	$1^+, 3^+, \dots$
	$A_{1u}$	$0^-, 4^-, \dots$

## Key results:

- $3\pi$  operators essential for the excited-state extraction  
c.f.  $\rho\pi$  operators in previous 2-meson  $a_1$  calculation

Lang et al. JHEP 04, 162 (2014)

- high-momentum states are required:  
 $\pi(0,0,0)\pi(+1,+1,0)\pi(-1,-1,0)$  etc..

- two levels exist below  $5\pi$  threshold

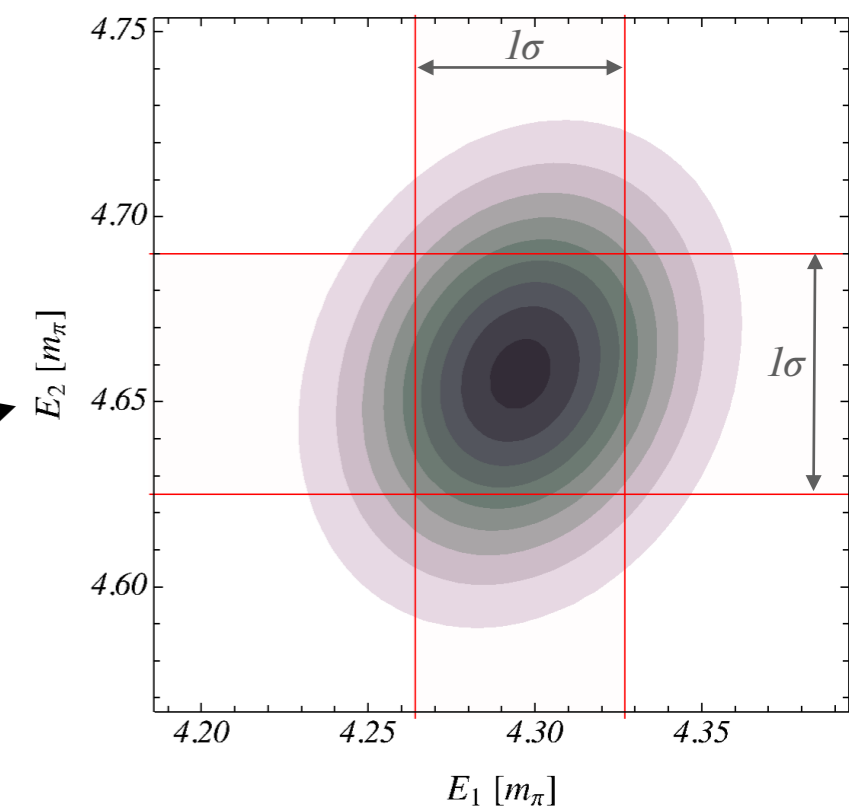

# QUANTIZATION CONDITION

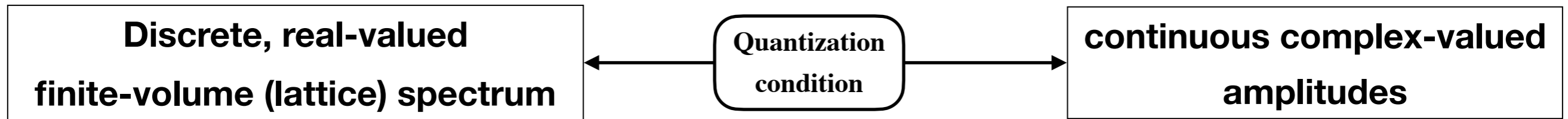

- established in 2-body: Lüscher's method, extensions... [Lüscher, Gottlieb, Rummukainen, Feng, Li, Liu, Döring, Briceño, Bernard, Meißner, Rusetsky...](#)
- 3-body methods matured [Bedaque, Blanton, Briceño, Davoudi, Döring, Griebhammer, Guo, Hammer, Hansen, MM, Meißner, Müller, Pang, Polejaeva, Romero-López, Rusetsky, Sharpe, Wu](#)

**Reviews: Hansen/Sharpe(2019) MM/Döring/Rusetsky(2021)**

# QUANTIZATION CONDITION

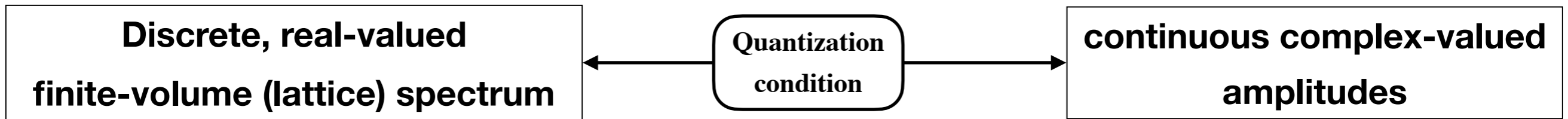

- established in 2-body: Lüscher's method, extensions... [Lüscher, Gottlieb, Rummukainen, Feng, Li, Liu, Döring, Briceño, Bernard, Meißner, Rusetsky..](#)

- 3-body methods matured

[Bedaque, Blanton, Briceño, Davoudi, Döring, Griebhammer, Guo, Hammer, Hansen, MM, Meißner, Müller, Pang, Polejaeva, Romero-López, Rusetsky, Sharpe, Wu](#)

**Reviews: Hansen/Sharpe(2019) MM/Döring/Rusetsky(2021)**

## Finite Volume Unitarity (FVU)

[MM, Döring EPJA \(2017\) PRL \(2019\)](#)

- extended to higher spin and coupled-channels: new degree of freedom (helicity,  $\lambda$ )

$$0 = \det \left[ B(s) + C(s) - 2L^3 E_{\mathbf{p}} \left( \tilde{K}_2^{-1}(s) - \Sigma_2^L(s) \right) \right]_{(\lambda'\lambda)(\mathbf{p}'\mathbf{p})}^{\Lambda}$$

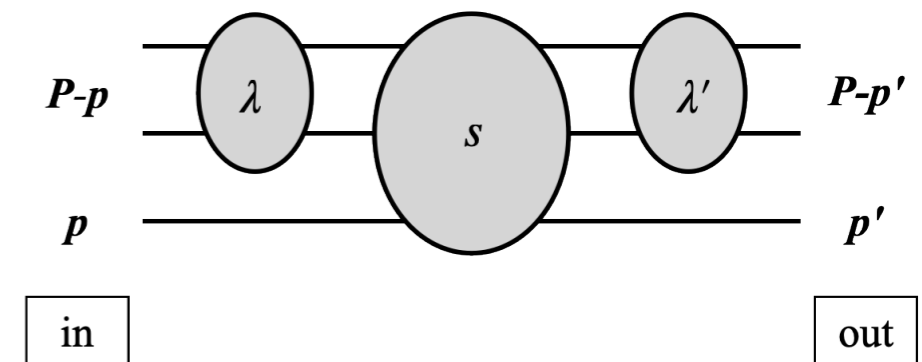

- $\infty$ -dim. determinant equation in  $\mathbf{p} \in \frac{2\pi}{L} \mathbf{Z}^3 \rightarrow$  practical applications require truncation
- $\rightarrow$  common to all quantization conditions

# QUANTIZATION CONDITION

$$0 = \det \left[ B(s) + C(s) - 2L^3 E_{\mathbf{p}} \left( \tilde{K}_2^{-1}(s) - \Sigma_2^L(s) \right) \right]_{(\lambda'\lambda)(\mathbf{p}'\mathbf{p})}^{\Lambda}$$

MM, Döring EPJA (2017)  
PRL (2019)

# QUANTIZATION CONDITION

$$0 = \det \left[ B(s) + C(s) - 2L^3 E_{\mathbf{p}} \left( \tilde{K}_2^{-1}(s) - \Sigma_2^L(s) \right) \right]_{(\lambda'\lambda)(\mathbf{p}'\mathbf{p})}^{\Lambda}$$

MM, Döring EPJA (2017)  
PRL (2019)

## two-body self-energy

- fixed by 2b-unitarity

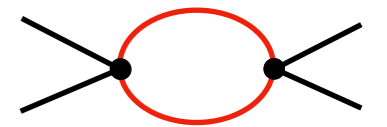

- no free parameters

# QUANTIZATION CONDITION

$$0 = \det \left[ B(s) + C(s) - 2L^3 E_{\mathbf{p}} \left( \tilde{K}_2^{-1}(s) - \Sigma_2^L(s) \right) \right]_{(\lambda'\lambda)(\mathbf{p}'\mathbf{p})}^{\Lambda}$$

MM, Döring EPJA (2017)  
PRL (2019)

## one-particle exchange

- fixed by 3b-unitarity

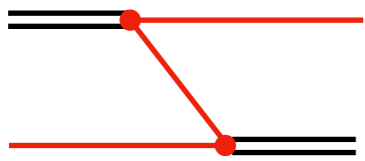

- no free parameters

## two-body self-energy

- fixed by 2b-unitarity

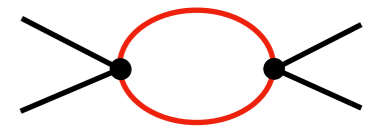

- no free parameters



# QUANTIZATION CONDITION

$$0 = \det \left[ B(s) + C(s) - 2L^3 E_p \left( \tilde{K}_2^{-1}(s) - \Sigma_2^L(s) \right) \right]_{(\lambda'\lambda)(\mathbf{p}'\mathbf{p})}^\Lambda$$

MM, Döring EPJA (2017)  
PRL (2019)

## one-particle exchange

- fixed by 3b-unitarity

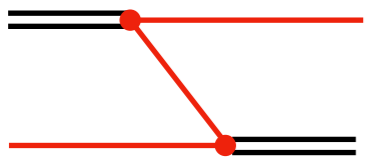

- no free parameters

## two-body kernel

- dynamics of  $l=1$   $\pi\pi$  system

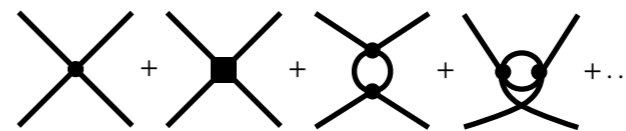

$$\tilde{K}_n^{-1}(s) = \sum_{i=0}^{n-1} a_i \cdot \sigma_p^i$$

- regular function  $\Rightarrow$  polynomial

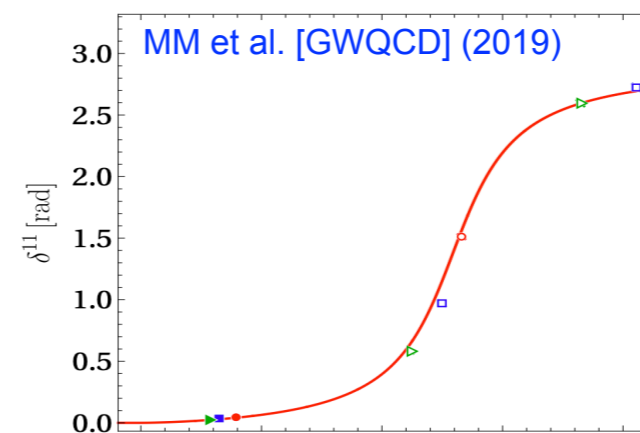

- parameters  $(a_0, a_1)$  from cross-channel fit to  $\pi\pi$  GWQCD levels

## two-body self-energy

- fixed by 2b-unitarity

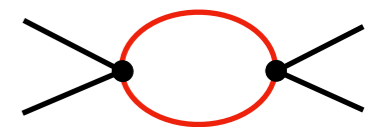

- no free parameters

# QUANTIZATION CONDITION

$$0 = \det \left[ B(s) + C(s) - 2L^3 E_{\mathbf{p}} \left( \tilde{K}_2^{-1}(s) - \Sigma_2^L(s) \right) \right]_{(\lambda'\lambda)(\mathbf{p}'\mathbf{p})}^{\Lambda}$$

MM, Döring EPJA (2017)  
PRL (2019)

## one-particle exchange

- fixed by 3b-unitarity

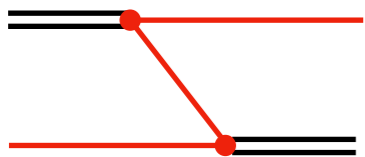

- no free parameters

## three-body force

- dynamics of  $\rho\pi$  system

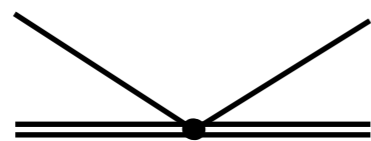

- regular function  $\Rightarrow$  Laurent series

$$C_{\ell'\ell}(s, \mathbf{p}', \mathbf{p}) = \sum_{i=-1}^{\infty} c_{\ell'\ell}^{(i)}(\mathbf{p}', \mathbf{p})(s - \mathbf{m}_{a_1}^2)^i$$

- fit to 3-body levels  $\rightarrow$  next slide

## two-body kernel

- dynamics of  $l=1$   $\pi\pi$  system

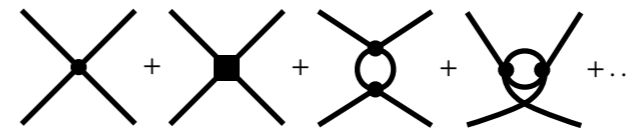

$$\tilde{K}_n^{-1}(s) = \sum_{i=0}^{n-1} a_i \cdot \sigma_p^i$$

- regular function  $\Rightarrow$  polynomial

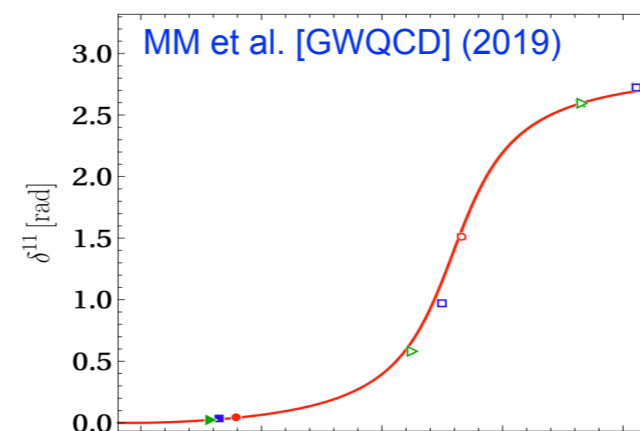

- parameters  $(a_0, a_1)$  from cross-channel fit to  $\pi\pi$  GWQCD levels

## two-body self-energy

- fixed by 2b-unitarity

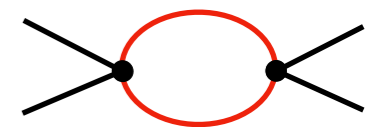

- no free parameters

# FROM LATTICE EIGENVALUES TO POLES

Last unknown (volume-independent) quantity: 3-body term  $C$

- $a_1$  pole is generated with/without explicit pole-term
- best description (with large correlations)

$$C_{\ell'\ell} = g_{\ell'} |\mathbf{p}'|^{\ell'} \frac{1}{s - \mathbf{m}_{a_1}^2} g_{\ell} |\mathbf{p}|^{\ell} + \mathbf{c} \delta_{\ell'0} \delta_{\ell 0}$$

- full resampling... accessing statistical errors

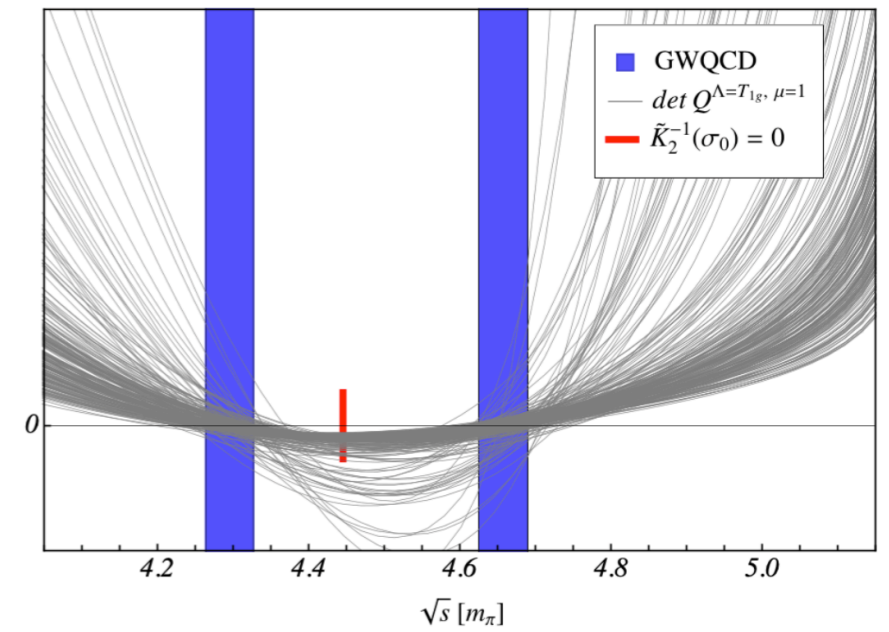

# FROM LATTICE EIGENVALUES TO POLES

Last unknown (volume-independent) quantity: 3-body term  $C$

- $a_1$  pole is generated with/without explicit pole-term
- best description (with large correlations)

$$C_{\ell'\ell} = g_{\ell'} |\mathbf{p}'|^{\ell'} \frac{1}{s - m_{a_1}^2} g_{\ell} |\mathbf{p}|^{\ell} + c \delta_{\ell'0} \delta_{\ell 0}$$

- full resampling... accessing statistical errors

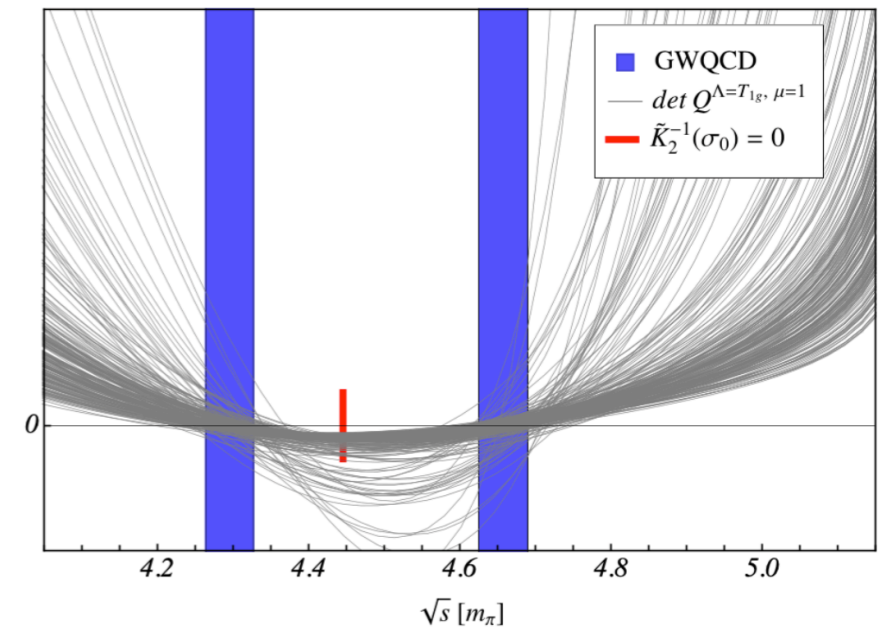

Infinite-volume scattering amplitude

- integral equation with all inputs fixed from lattice QCD results

$$T^c = B + C + \int \frac{d^3\ell}{(2\pi)^3} \frac{(B + C)}{2E_\ell} \frac{1}{\tilde{K}_n^{-1} - \Sigma_n} T^c$$

- contour deformation of spectator momenta
- analytic continuation to 2.Riemann sheet

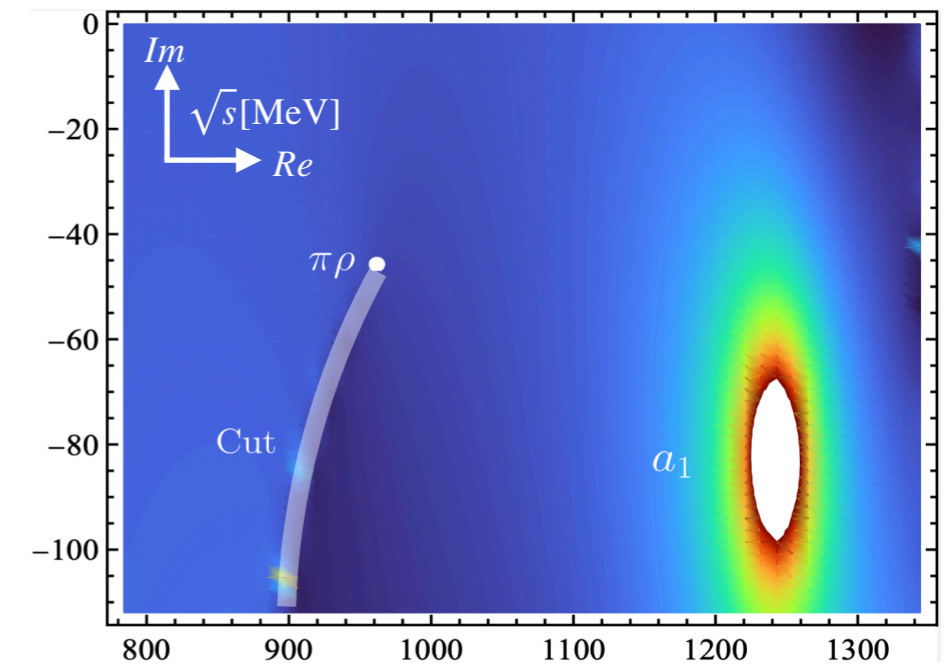

# RESULTS

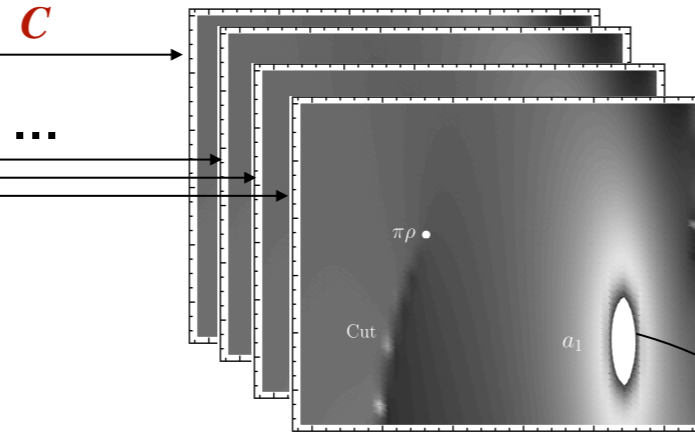
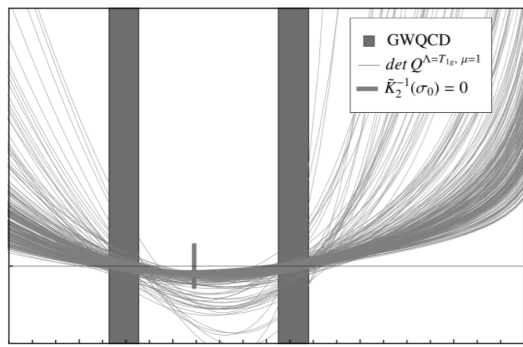

- $m_\pi = 224$  MeV
- 2000 resampling sets
- distribution of poles is finite
- 90% @  $\sim((1110..1210) - (20..70)i)$  MeV

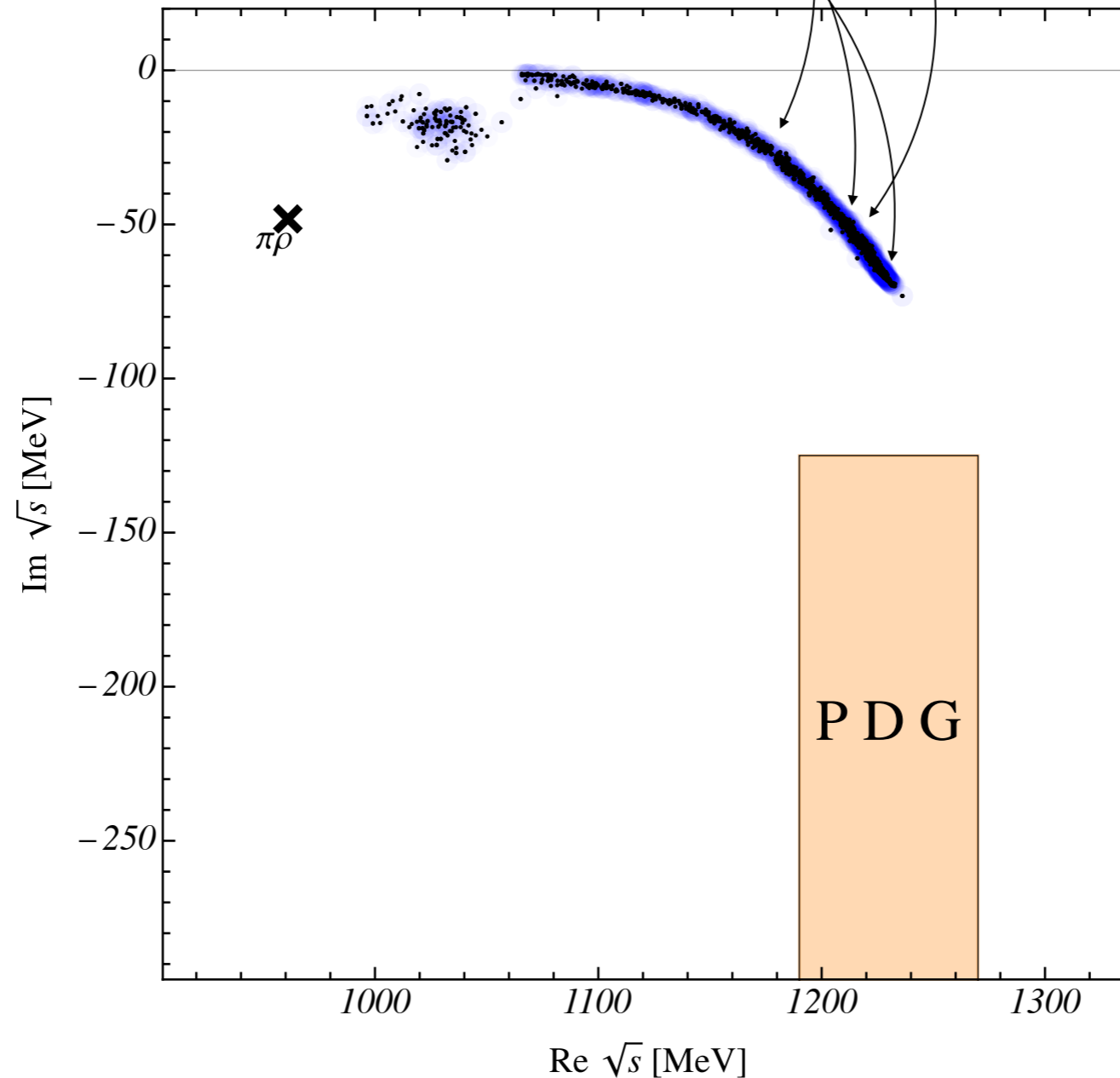

# RESULTS & CHECKS

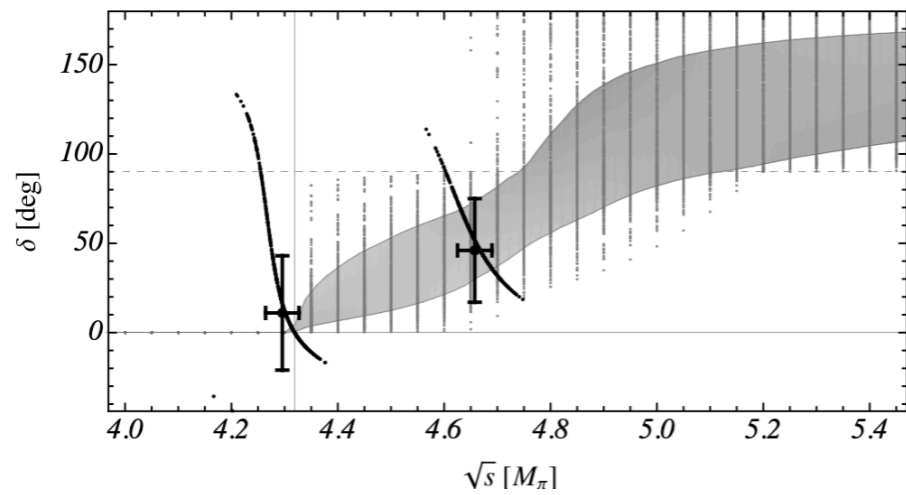

**Can one use two-body approximation?**

- Breit-Wigner parametrization
  - 2-body Lüscher quantization condition
- ⇒ very crude approximation!

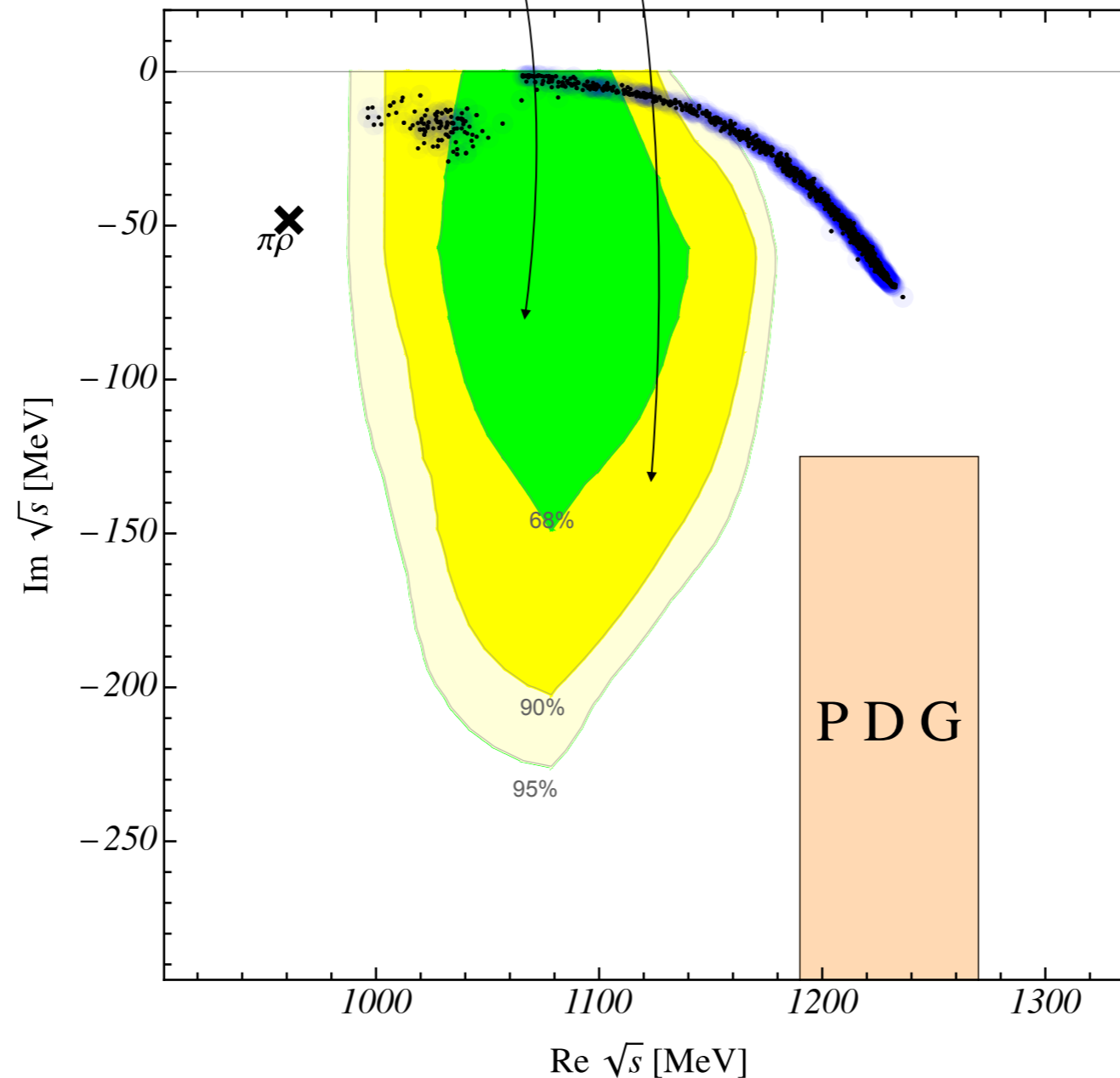

# RESULTS & CHECKS

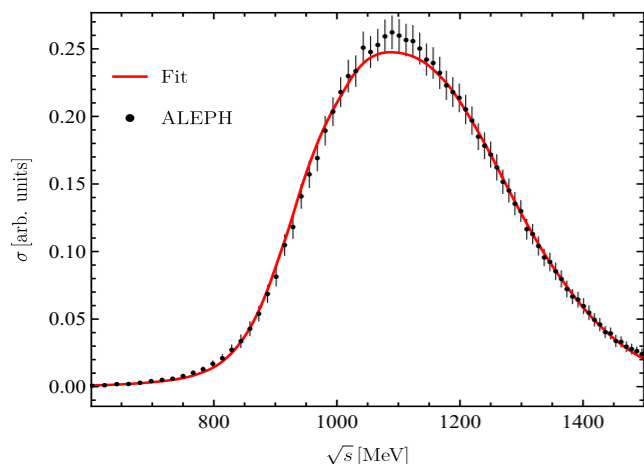

$C$

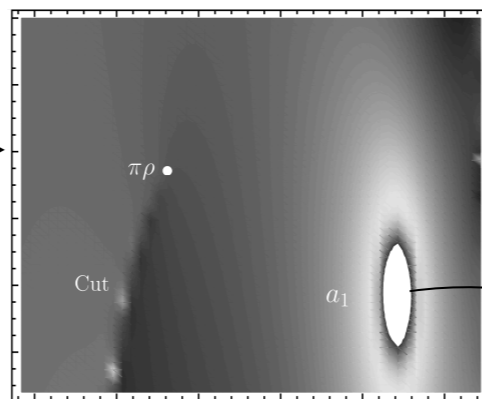

What does phenomenology says?

- $\tau \rightarrow (\pi\pi\pi)\nu_\tau$  from ALEPH@CERN
- fit to line shape to fix  $C$

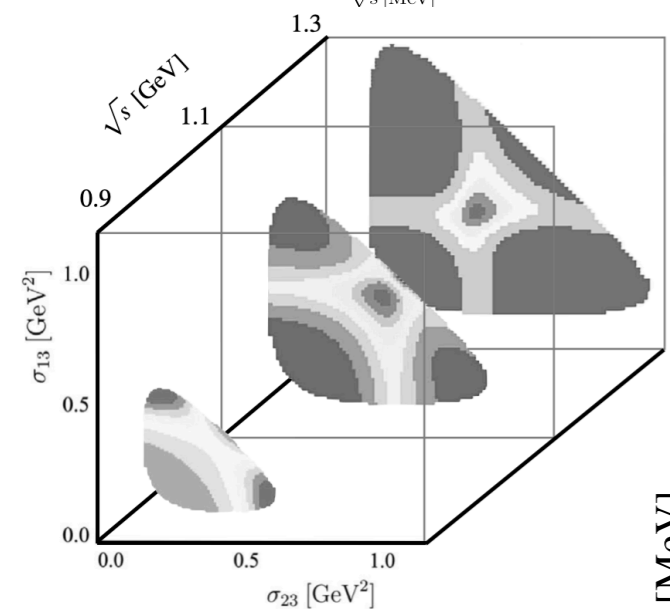

cf. Sadasivan/  
MM/Döring(2020)

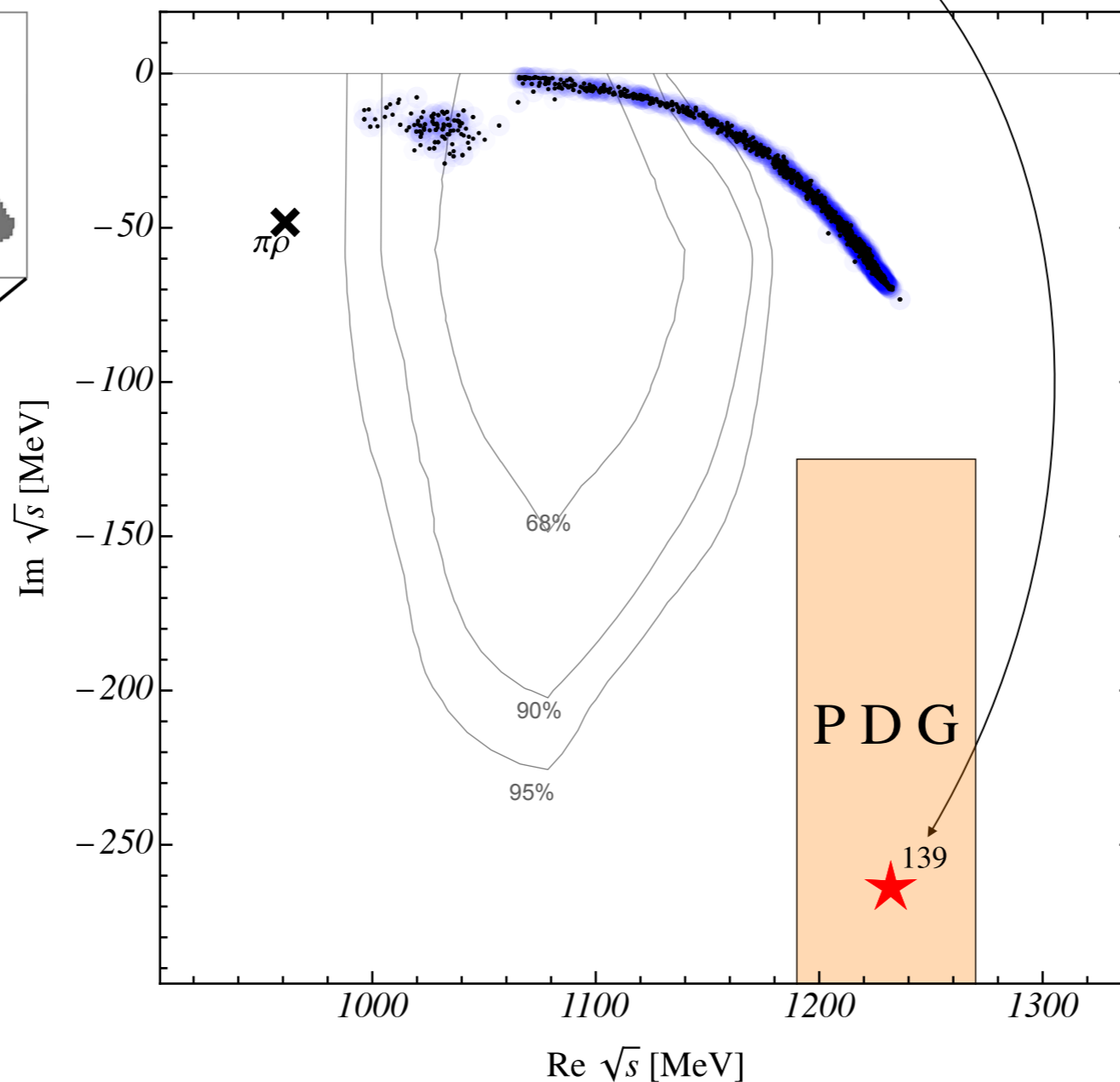

# MOTIVATION

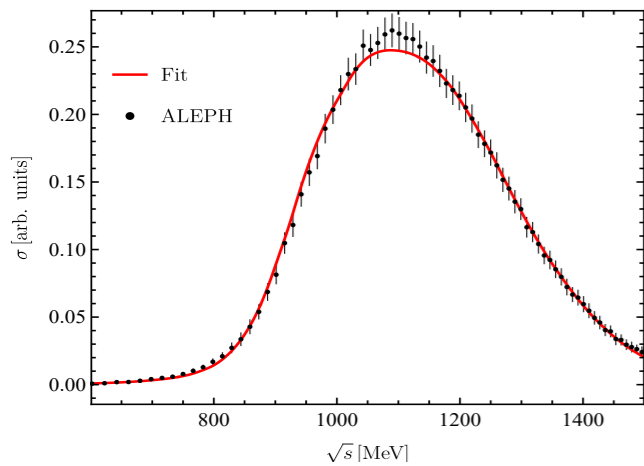

$C$

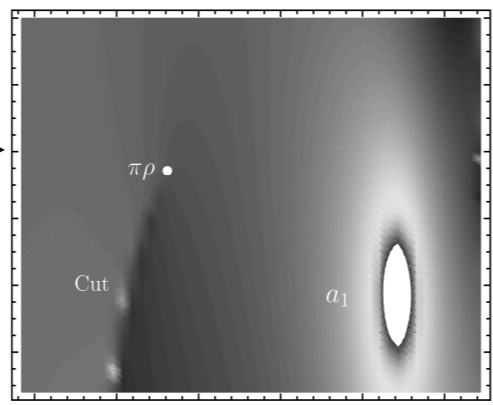

What does phenomenology says?

- $\tau \rightarrow (\pi\pi\pi)\nu_\tau$  from ALEPH@CERN
- fit to line shape to fix  $C$

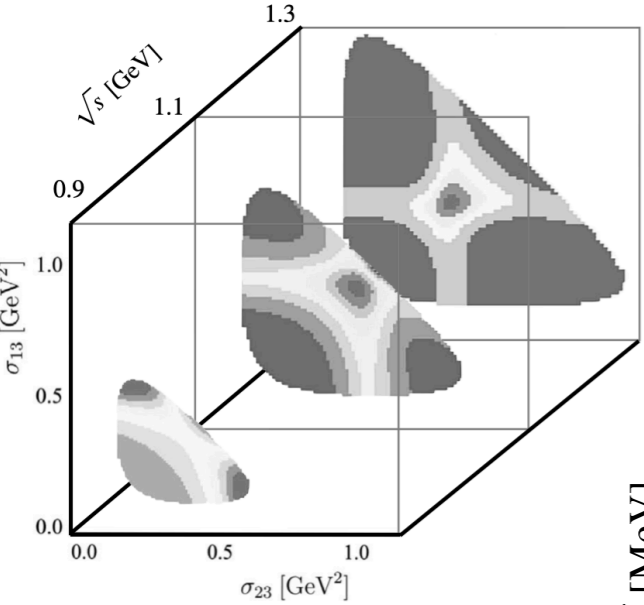

cf. Sadasivan/  
MM/Döring(2020)

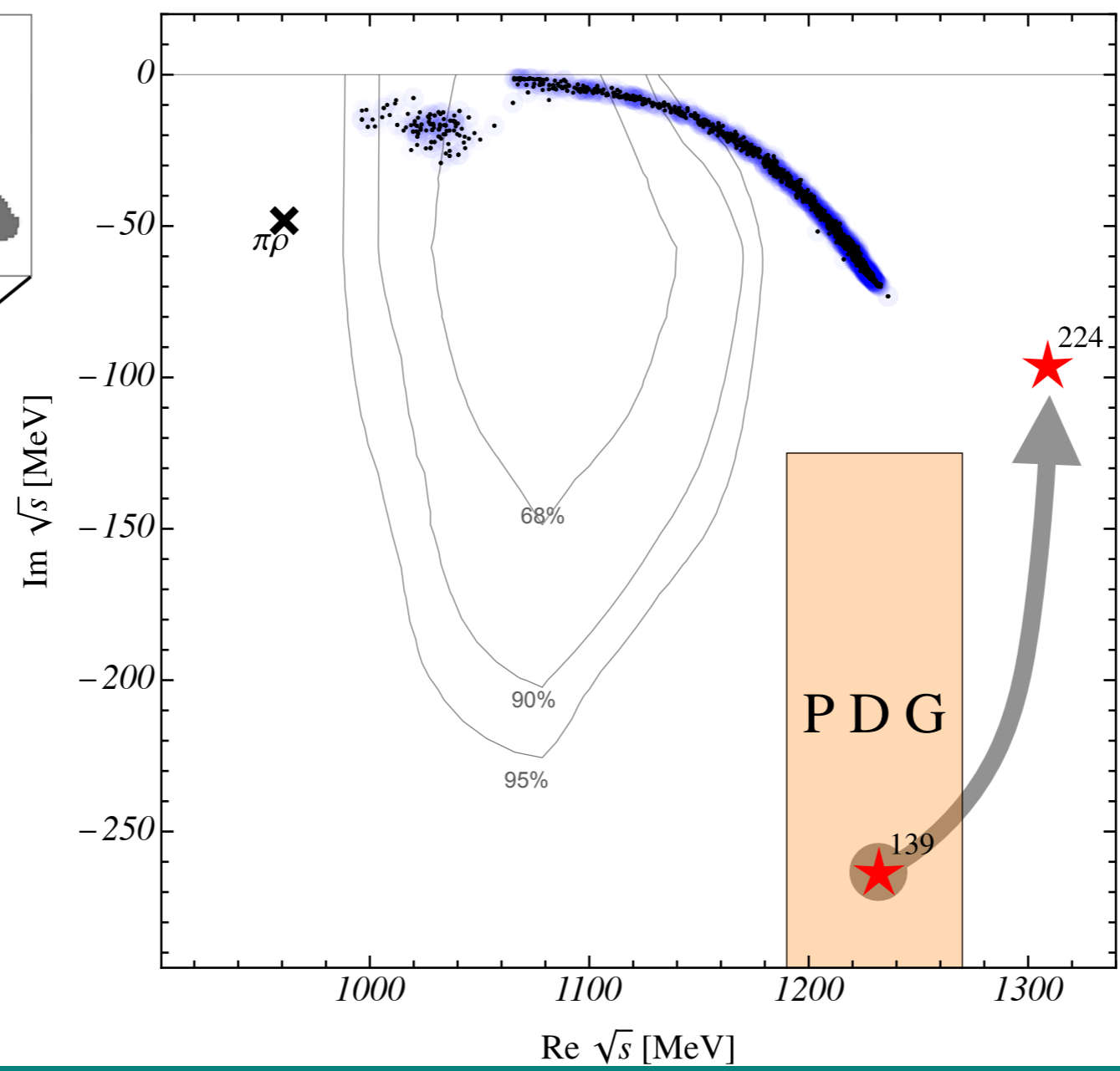

(naive) **chiral extrapolation**  
confirms expectations:

- $a_1$  becomes heavier
- ... and narrower



## Summary

- First-ever determination of  $a_1(1260)$  parameters from lattice QCD
- Lattice QCD levels with 1/2/3-meson operators calculated
- 3-body quantization condition extended to spin-1 systems
- infinite-volume amplitude solved with complex integration contour and for complex energies
- pole positions and couplings are determined

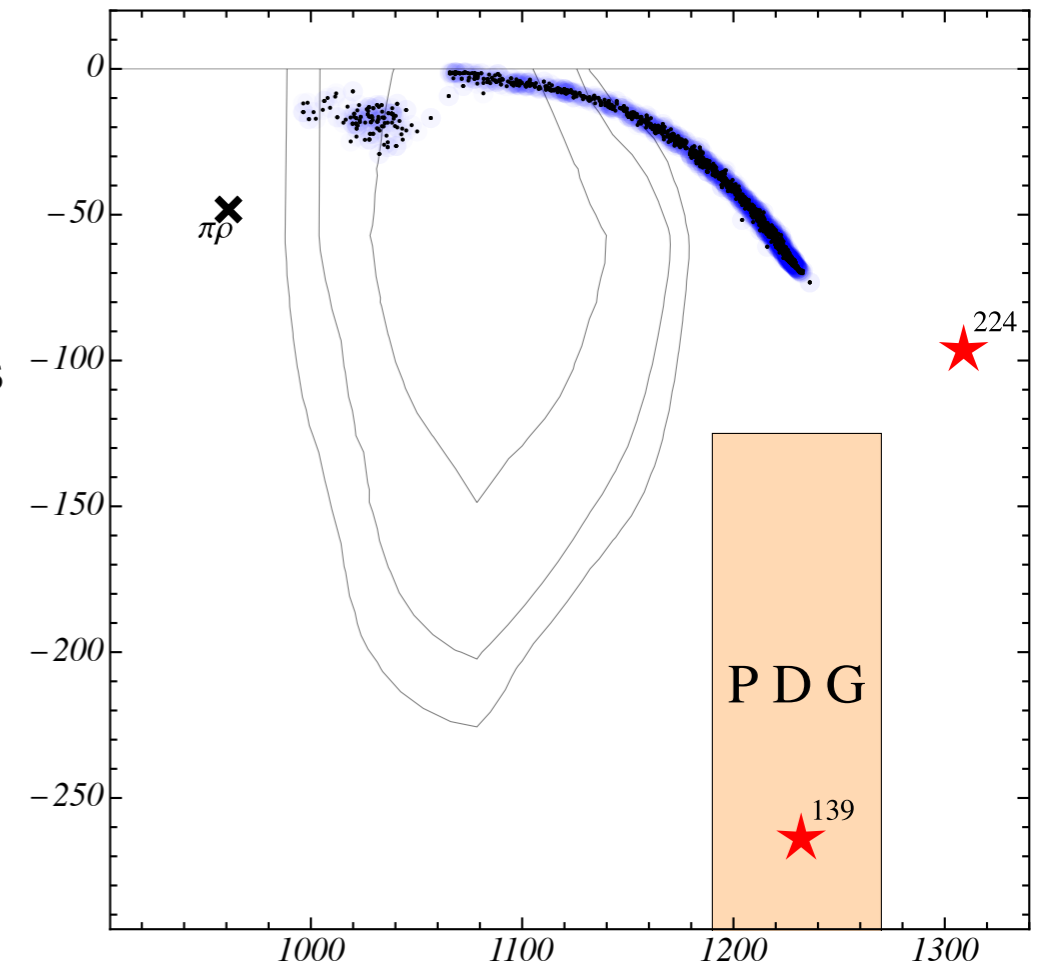

## Summary

- First-ever determination of  $a_1(1260)$  parameters from lattice QCD
- Lattice QCD levels with 1/2/3-meson operators calculated
- 3-body quantization condition extended to spin-1 systems
- infinite-volume amplitude solved with complex integration contour and for complex energies
- pole positions and couplings are determined

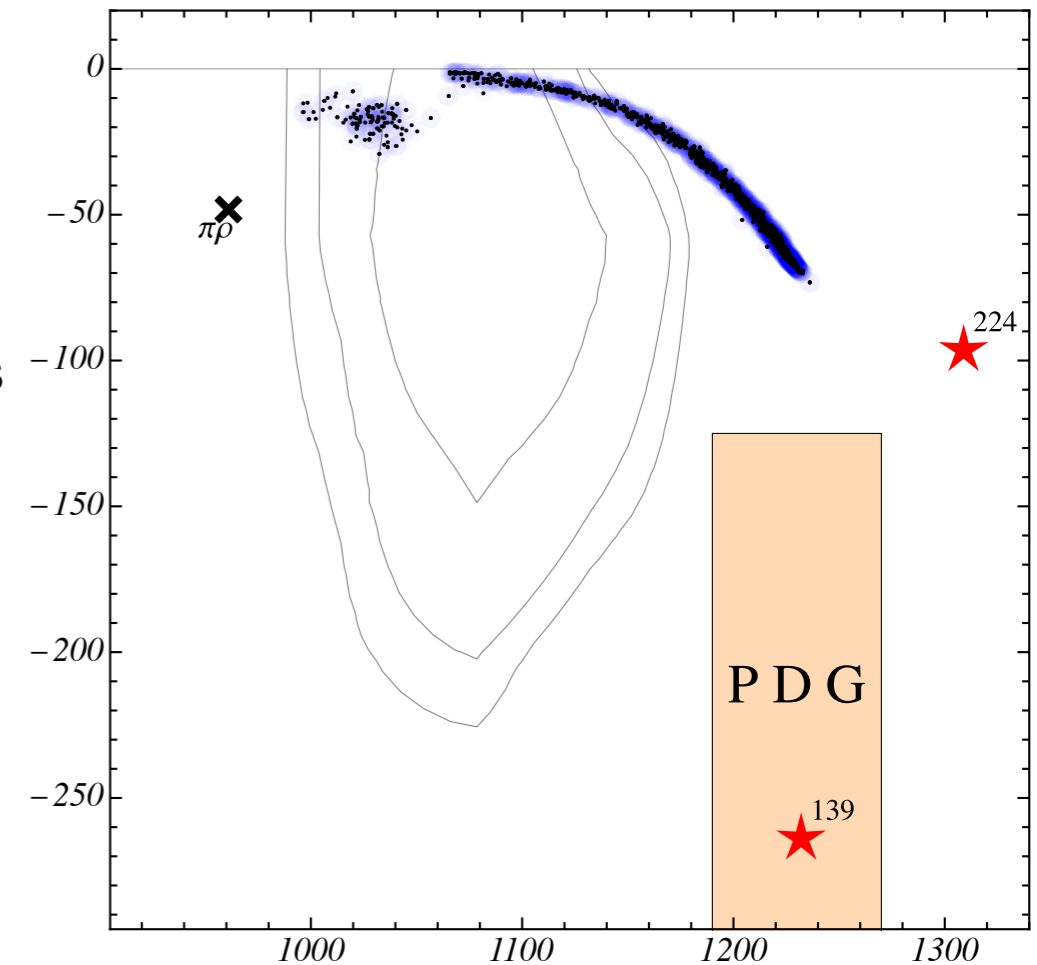

## Outlook

- More lattice levels (another setup:  $m_\pi, L$ ):
  - precise determination of  $a_1$  parameters
  - importance of the  $\sigma\pi$  channels
  - chiral trajectory of three-body term  $\mathcal{C}$

Unitarity

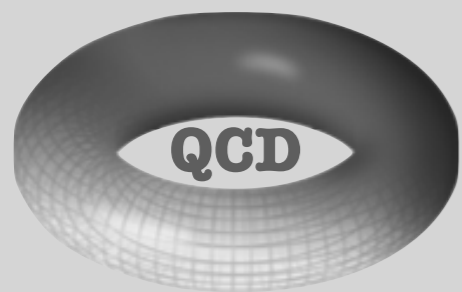

ChPT

**THEORY**

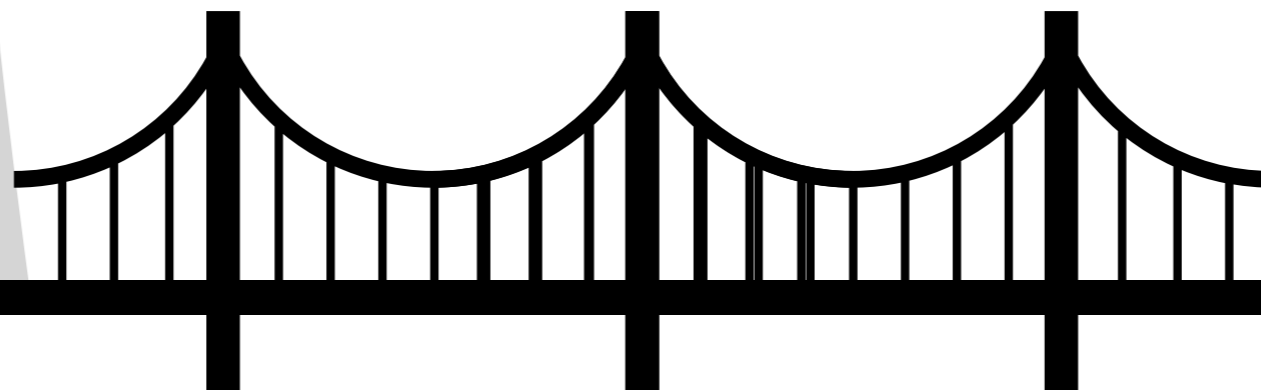
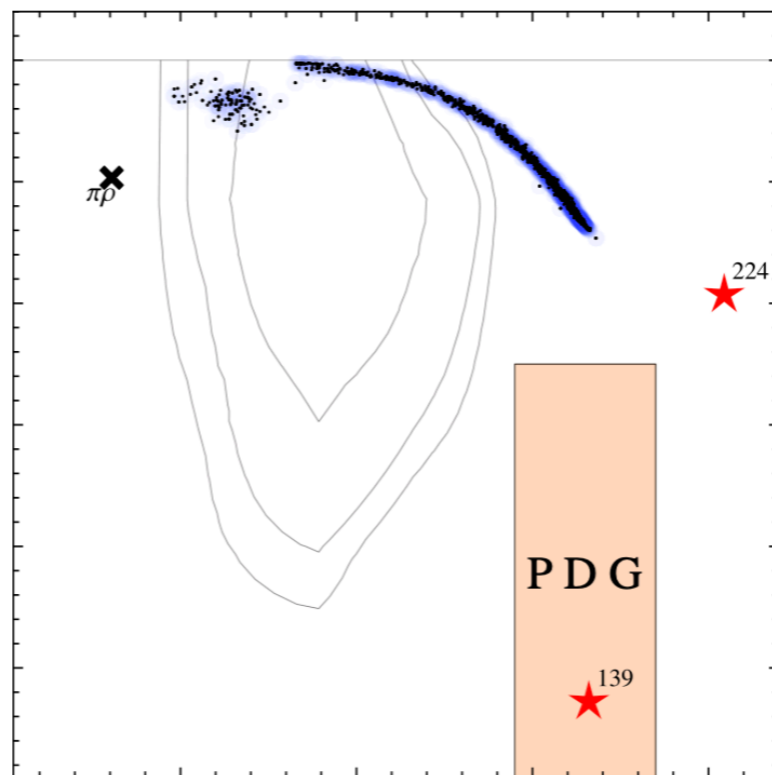

LHC

GlueX

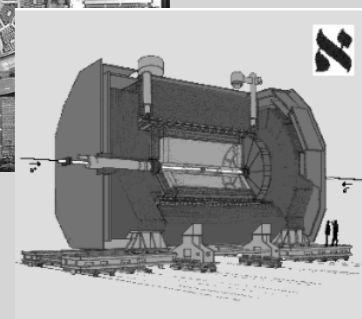
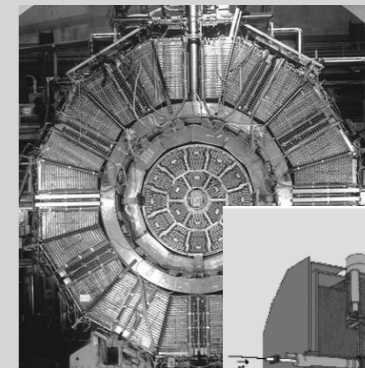

The ALEPH Detector

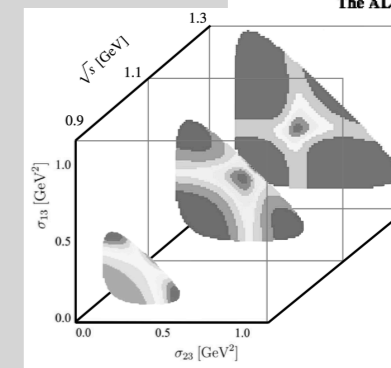

**EXPERIMENT**

**THANK YOU**